

## RCBOs Ex9BL-N, 6 kA



- Residual Current circuit Breakers with Overload protection according to EN 61009
- Rated breaking capacity  $I_{cn}$  6 kA
- 1+N-pole version
- Rated residual current 30, 100, 300 mA
- Rated currents up to 40 A
- B and C tripping characteristics of installed circuit breaker
- AC and A type of RCBO
- 2-module width
- Suitable for applications from -25 to +40°C

Ex9BL residual current circuit breakers are suitable for domestic as well as industrial applications. They are based on combination of residual current device with permanent magnet principle and circuit breaker with thermal overload release and magnetic short circuit current release. It brings the advantage of voltage independent function of the residual current device. Adequate voltage is only necessary when testing the RCBO with the T test button. Magnetic RCBOs should be tested regularly with a period of one month.

### Type Key

Ex9	BL	-N	1PN	B	16A	A	30mA
↓	↓	↓	↓	↓	↓	↓	↓
Product family	Product	Rated breaking capacity	Poles	Tripping characteristic of MCB	Rated current	Sensitivity to type of current	Rated residual current
Ex9	BL: RCBO	-N: 6 kA	1P+N	B C	6 — 40 A	—: AC A: A	30 mA 100 mA 300 mA

## RCBOs Ex9BL-N, 6 kA

### AC type, characteristic C

- AC type of residual current circuit breaker sensitive on residual AC current
- C characteristic of installed circuit breaker
- Without time delay
- Surge current-proof 250 A
- Suitable for protection of people in case of direct and indirect contact with live parts and exposed conductive parts during a fault, respectively
- Selective with upstream installed S or S+A type RCCB



Rated current	Rated residual current	MCB tripping char.	Article No.	Type	Packing
6 A	30 mA	C	107627	Ex9BL-N 1P+N C6 30mA	1/6/72
10 A	30 mA	C	107628	Ex9BL-N 1P+N C10 30mA	1/6/72
13 A	30 mA	C	107629	Ex9BL-N 1P+N C13 30mA	1/6/72
16 A	30 mA	C	107630	Ex9BL-N 1P+N C16 30mA	1/6/72
20 A	30 mA	C	107631	Ex9BL-N 1P+N C20 30mA	1/6/72
25 A	30 mA	C	107632	Ex9BL-N 1P+N C25 30mA	1/6/72
32 A	30 mA	C	107633	Ex9BL-N 1P+N C32 30mA	1/6/72
40 A	30 mA	C	107634	Ex9BL-N 1P+N C40 30mA	1/6/72
6 A	100 mA	C	107659	Ex9BL-N 1P+N C6 100mA	1/6/72
10 A	100 mA	C	107660	Ex9BL-N 1P+N C10 100mA	1/6/72
13 A	100 mA	C	107661	Ex9BL-N 1P+N C13 100mA	1/6/72
16 A	100 mA	C	107662	Ex9BL-N 1P+N C16 100mA	1/6/72
20 A	100 mA	C	107663	Ex9BL-N 1P+N C20 100mA	1/6/72
25 A	100 mA	C	107664	Ex9BL-N 1P+N C25 100mA	1/6/72
32 A	100 mA	C	107665	Ex9BL-N 1P+N C32 100mA	1/6/72
40 A	100 mA	C	107666	Ex9BL-N 1P+N C40 100mA	1/6/72
6 A	300 mA	C	107691	Ex9BL-N 1P+N C6 300mA	1/6/72
10 A	300 mA	C	107692	Ex9BL-N 1P+N C10 300mA	1/6/72
13 A	300 mA	C	107693	Ex9BL-N 1P+N C13 300mA	1/6/72
16 A	300 mA	C	107694	Ex9BL-N 1P+N C16 300mA	1/6/72
20 A	300 mA	C	107695	Ex9BL-N 1P+N C20 300mA	1/6/72
25 A	300 mA	C	107696	Ex9BL-N 1P+N C25 300mA	1/6/72
32 A	300 mA	C	107697	Ex9BL-N 1P+N C32 300mA	1/6/72
40 A	300 mA	C	107698	Ex9BL-N 1P+N C40 300mA	1/6/72

## General parameters

Combination of MCB and RCCB in one case - saves 50 % space in comparison to combination of stand-alone MCB and RCCB
Tripping characteristics of installed circuit breaker B and C
AC and A type of residual current device
1+N-pole version
Suitable for household as well as industrial applications
Permanent magnet principle of residual current device - Voltage independent tripping function
Magnetic RCBOs should be tested regularly with a period of one month. This is a responsibility of the user of an installation given by law
Signaling of contacts status

## Electrical parameters

Tested according to	EN 61009
Rated operating voltage $U_e$	230 V AC
Min. voltage for RCD function	voltage independent
Voltage range of the test button T	195.5 — 253 V AC
Rated frequency f	50/60 Hz
Rated breaking capacity $I_{cn}$	6 kA
Rated current $I_n$	6 — 40 A
Rated residual current $I_{\Delta n}$	30, 100, 300 mA
Sensitivity to residual current	AC type - AC residual current A type - residual AC and pulsating DC current
Time characteristic of RCD	undelayed type
Tripping characteristics of MCB	B, C
Rated impulse withstand voltage $U_{imp}$	4 kV
Rated insulation voltage $U_i$	500 V
Surge current proof	250 A
Mechanical service life	20 000 operation cycles
Electrical service life	4 000 operation cycles
Selectivity class	3
Back-up fuse/breaker	max. 125 A gG
Line voltage connection	arbitrary above or below

## Mechanical parameters

Device width	36 mm
Device height	85 mm (including rail clip)
Frame size	45 mm
Mounting	easy fastening onto 35 mm device rail (DIN)
Degree of protection	IP20
Terminals	combined lift + open mouthed
Terminal capacity	1 — 25 mm <sup>2</sup>
Fastening torque of terminals	1.5 — 2.5 Nm
Busbar thickness	0.8 — 2 mm
Ambient temperature	-25 — +40 °C
Altitude	≤ 2000 m
Relative humidity	≤ 95 %
Resistance to humidity and heat	class 2
Pollution degree	2
Installation class	III
Weight	0.2 kg

## Dimensions

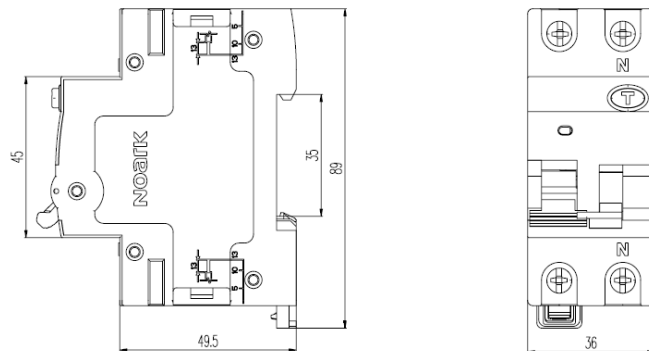

## Wiring diagram

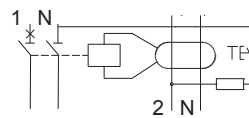

1P+N

## Tripping characteristics of MCB

Characteristic B

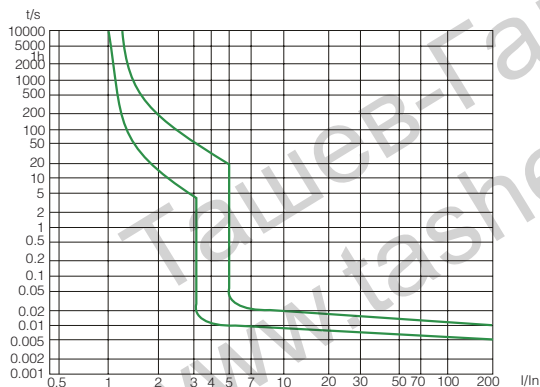

Characteristic C

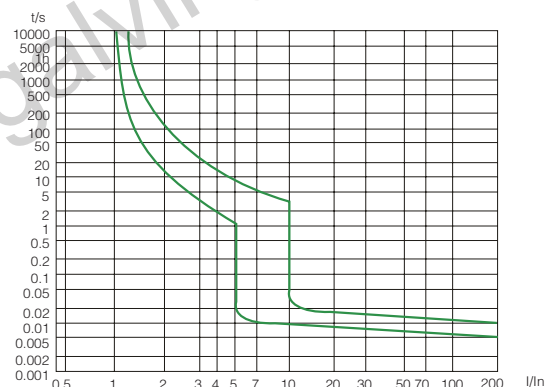

## Tripping characteristics of RCD

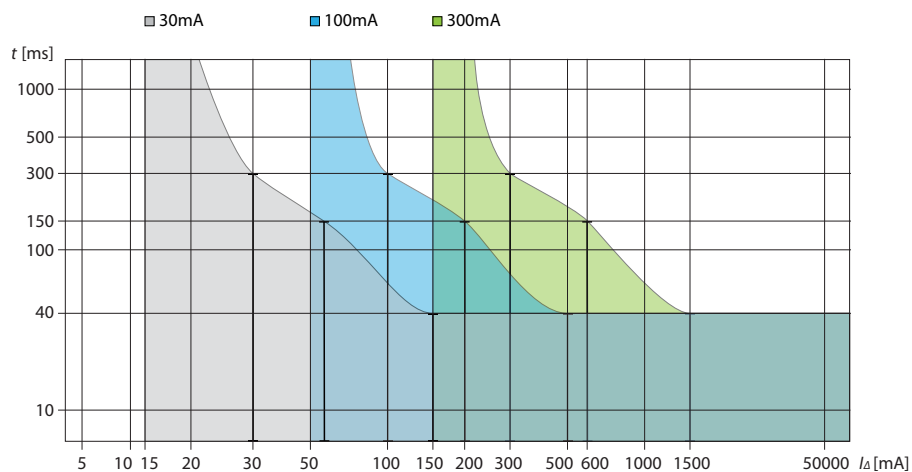

## Technical Data Ex9BL-N

### Residual Current current Breakers with Overload protection Ex9BL-N, 6 kA

#### Dependence of Tripping Characteristics on Ambient Temperature

T [°C]	I <sub>n</sub> (T) [A]							
	6 A	10 A	13 A	16 A	20 A	25 A	32 A	40 A
-20	8	13.5	17	20	24.5	29.8	39.5	50.5
-15	7.8	13.3	16.8	19.8	24.3	29.7	39.3	50.4
-10	7.6	13	16.5	19.5	24	29.5	39	50.2
-5	7.3	12.7	16.1	19.2	23.8	29.3	38.8	50
0	7.2	12.5	15.8	19.1	23.7	29.2	38.6	48.8
5	7	12.3	15.5	18.8	23.5	29	38.4	48.6
10	6.8	12.1	15.2	18.6	23.3	28.8	38.2	48.4
15	6.6	12	14.9	18.5	23.1	28.6	38	48.1
20	6.4	11.8	14.7	18.3	22.8	28.4	37.8	47.8
25	6.2	11.5	14.1	18	22.6	28.2	37.5	47
30	6	10	13	16	20	25	32	40
35	6	9.9	12.8	15.7	19.7	24.6	31.5	39.2
40	5.9	9.8	12.5	15.4	19.3	24.3	31.1	38.8
45	5.83	9.8	12.2	15.1	18.8	24	30.8	38.3
50	5.72	9.6	11.7	14.9	18.5	23.8	30.1	38
55	5.65	9.5	11.5	14.7	18.2	23.5	29.5	36.5
60	5.5	9	11.2	14.5	17.8	23	28.5	35
65	5.4	8.6	11	14	17.5	22	27.5	34
70	5.2	8	10.8	13.8	17.3	21.5	27	32.5

#### Power loss

I <sub>n</sub> [A]	6 A	10 A	13 A	16 A	20 A	25 A	32 A	40 A
P [W]	1.8	2.5	3.5	4	5	5.8	6.5	7.8

## Breaker fault detection by toggle position

### 1. Overload or short-circuit detected

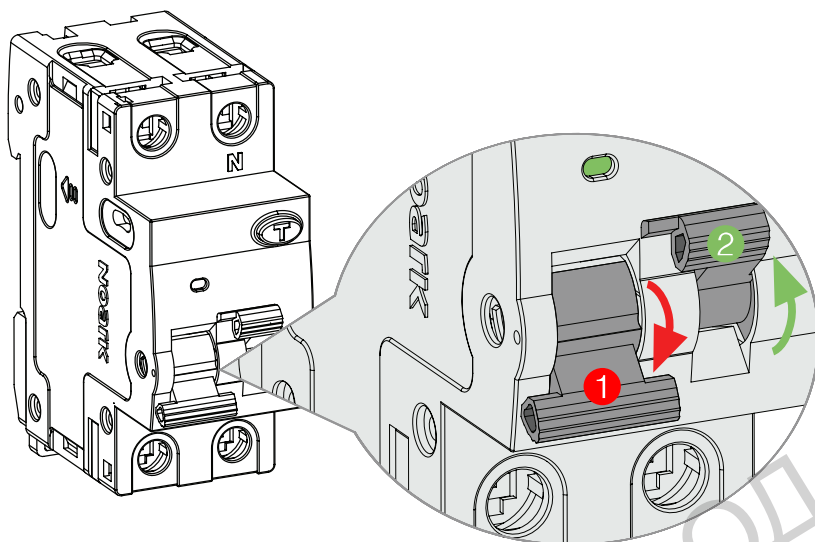

1 Toggle in the „OFF“ position

2 Toggle in the „ON“ position

$I > I_n$  (MCB)

### 2. Residual current detected

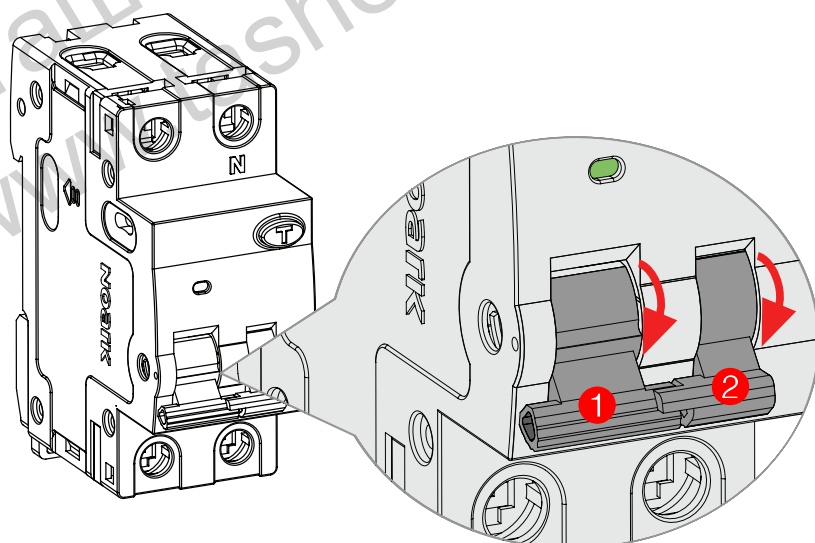

1 Toggle in the „OFF“ position

2 Toggle in the „OFF“ position

$I \Delta n$  (RCD)